

"Microbox"

DC Models

MBOX 125/2DC /H

MBOX 125/2DC204 /H



**Continuous Mechanical Extract Ventilation
Unit with Low Energy DC Motor - for
domestic and commercial use**

**Installation, Operating and Maintenance
Instructions**





"MICROBOX" - CONTINUOUS MECHANICAL EXTRACT UNIT INSTALLATION AND OPERATING INSTRUCTIONS

PLEASE READ THE FOLLOWING INSTRUCTIONS VERY CAREFULLY BEFORE USING THE PRODUCT. THE MANUFACTURER WILL NOT BE HELD RESPONSIBLE AND DECLINES ANY AND ALL LIABILITY FOR DAMAGE CAUSED TO PERSONS OR PROPERTY DUE TO IMPROPER USE WITH REFERENCE TO THE PRECAUTIONS OUTLINED IN THIS MANUAL.

THIS MANUAL MUST ALWAYS BE READILY AVAILABLE.

MBOX125/2DC: 5"/125mm spigot, for dwellings up to 185m², max capacity 388m³/hr
MBOX125/2DCH - with humidistat

MBOX125/2DC204: 204 x 60mm spigot, for dwellings up to 185m², max capacity 388m³/hr
MBOX125/2DC204H - with humidistat



ATTENTION : This symbol indicates that care must be taken in installing this product in order to avoid (potentially lethal) injury both to installer and user. This instruction **MUST** be followed for installation.

1. Do not use this product for any purpose other than that for which it was designed and as shown in this leaflet.
2. Remove all packaging and check that your fan has not been damaged in transit. If in doubt, contact your supplier.
3. Do not leave packaging within the reach of children or unskilled people. Dispose of hazardous waste (polystyrene, plastic, polypropylene, etc.) responsibly.
4. If the product is dropped or badly knocked, contact your supplier, dealer or manufacturer to ensure that it is operating properly.
5. Using any electrical equipment requires compliance with basic safety rules:
 - the product must not come into contact with liquid of any sort
 - the product must not be operated by children or other unskilled people.
6. The product should only be connected to the mains electricity supply or electrical outlet if:
 - your electrical voltage and frequency correspond to those shown on the rating label.
 - the capacity of your electricity supply is sufficiently powerful to operate the product at its maximum power
 If this is not the case, contact professionally qualified personnel.
7. Before carrying out any maintenance or cleaning operation, the product must be switched off and disconnected from the main power supply..
8. If a fault, malfunction or anomaly of any type occurs, the product should be made inoperative (by turning off the switch and by disconnecting it from the mains electricity supply) and qualified personnel contacted immediately. Always request original spare parts to carry out any repairs.
9. If the product needs to be removed, turn off the mains electricity supply and disconnect the appliance
10. The unit should be installed in a safe location as far away as possible from children and/or unskilled people.
11. The electricity system to which the product is connected must comply with the current standards.
12. **In order to comply with Construction (Design & Management) Regulations, sufficient access for safe maintenance or removal following installation, MUST be provided for this product.**



WARNING : This symbol indicates that care must be taken to avoid damaging your product when following these instructions

1. This product is professionally manufactured and complies with the current standards regarding electrical equipment
2. This product conforms with the EEC directive EMC 89/336 concerning the suppression of radio interference and electromagnetic compatibility.
3. This product must not be used in an ambient temperature greater than 40 °C (104 °F).
4. Do not leave the product exposed to the weather (rain, sun, snow, etc.).
5. Possible product applications are indicated in this leaflet.
6. Do not place the unit or any part of it in water or liquids, except as indicated in the cleaning and maintenance section.
7. When cleaning or performing routine maintenance, check the condition of the appliance.



8. To avoid the risk of fire, do not use the product in the presence of inflammable substances or vapours such as alcohol, insecticides, gasoline, etc.
9. The air or fumes being extracted must be clean and free from greasy particles, soot, chemicals and corrosive agents, inflammable or explosive mixes.
10. The device must be installed by professionally qualified personnel.
11. The product must be connected to the electricity supply by means of a triple-pole switch with a minimum contact opening distance greater than 3 mm.
12. To ensure optimum operation, do not block the air intake and exit vents.
13. If the room being ventilated contains a fuel burning appliance, the installer must ensure that air replacement is adequate both for the fan and the fuel burning appliance.
14. The unit should not be used as an activator for water heaters, stoves, etc.
15. Any ducting used must be free from blockages
16. Where ducting is installed in an unheated space, all of the ducts should be insulated.
17. Your fan must not be exhausted into a duct which is already used for any other purpose (see Approved Document F1 2006 for guidance)

OPERATION

1. The **Microbox** is suitable for ceiling or wall installation.
2. If one of the spigots is not connected to ducting, a safety grille **MUST** be fitted to that spigot, so that it is impossible for any moving part to be touched.
3. This fan runs continuously at a preset trickle speed and has an independently switched boost speed. The trickle & boost speeds are selectable during the installation by adjusting the trimmers in the controller (see wiring diagrams).
4. An overrun timer is fitted to this product. When the boost is switched off, the fan will continue to run at boost 30 minutes, after which the speed will return to trickle. The length of the overrun period can be adjusted from 0-30 minutes using the TIMER adjustment on the control board (see page 6).

NOTE: for models incorporating an internal humidistat, the boost speed will also be activated whenever the humidity level of the extracted air rises above a preset level (factory set). When the humidity level is reduced back below the preset level, the fan will return to normal (trickle) speed.

ELECTRICAL CONNECTION

WARNING: these appliances must be earthed and all wiring must conform to current IEE Regulations and all applicable standards and Building Regulations.

- The unit is suitable for 230V, 50Hz Single phase supply fused.
- The unit is supplied with a mains rated 4 core flexible cord (black, brown, grey and green/yellow)
- A triple pole switch having a minimum contact separation of 3mm must be used for isolation and located close to the product.
- Boost controls must not be located within 1 metre of a cooker or where they may be affected by excessive heat or moisture
- Boost controls should be clearly identified and conveniently located.
- The boost speed can be triggered by a switched live connection from a variety of external devices including:
 - PIRFF (passive infra red)*
 - DRH240 (dynamic remote humidistat)*
 - THM (thermostat)*
 - a light switch (if more than one light switch is used, **each one must be a double pole switch**)
 - a remote switch/pull cord

(*PIRFF, DRH240 and THM may have integral over-run timer which controls the length of time that the fan will continue to operate at its boost speed after the boost has been switched off)

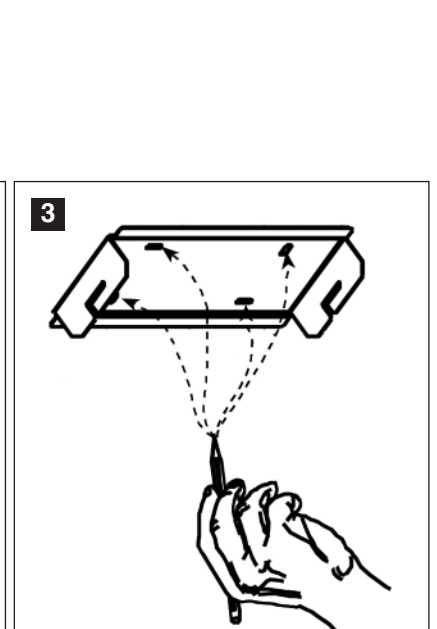
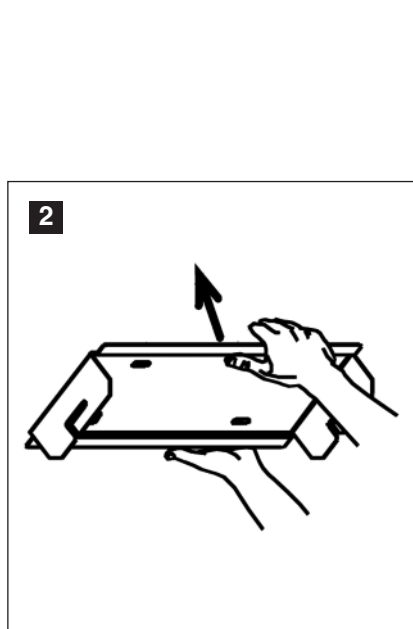
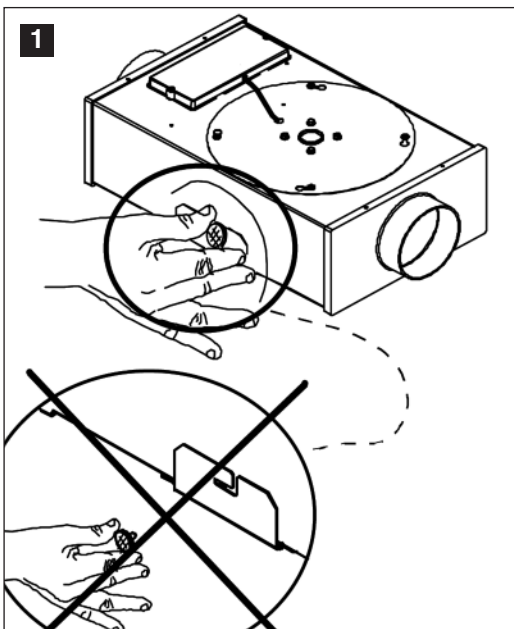
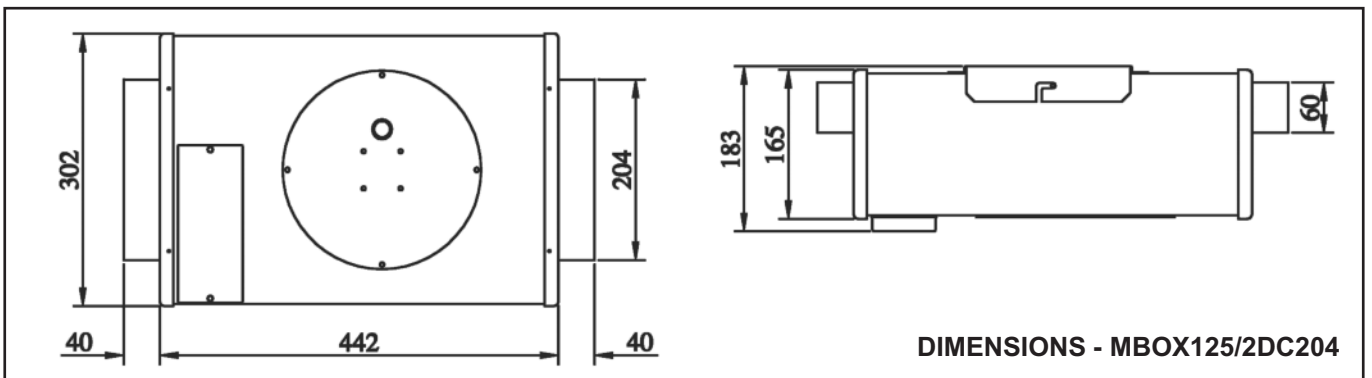
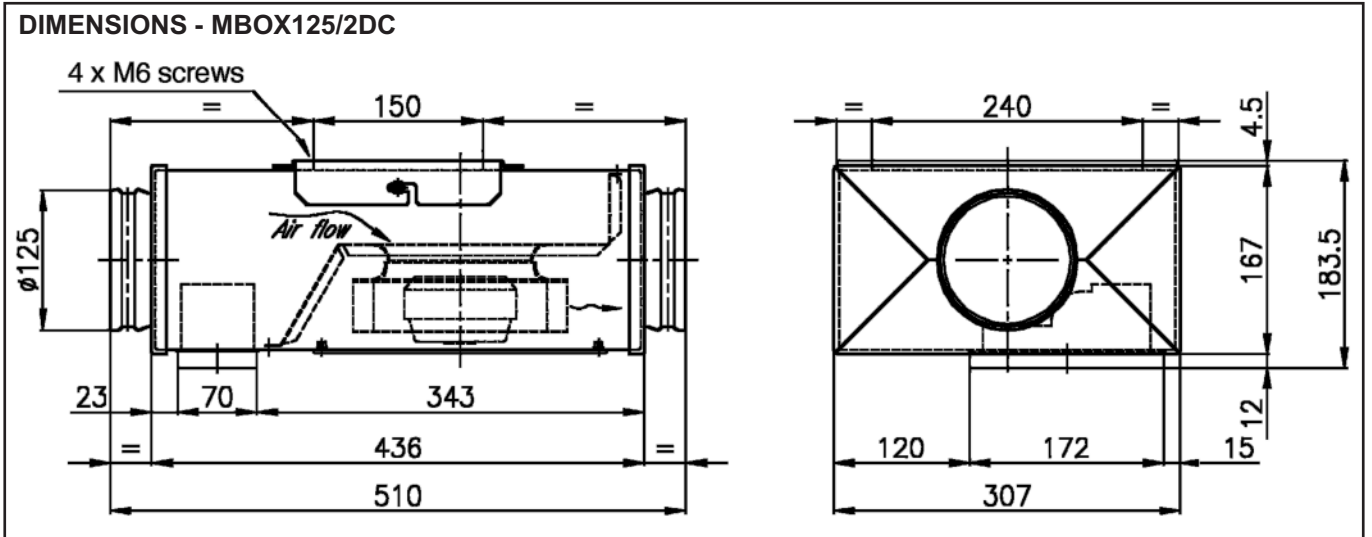
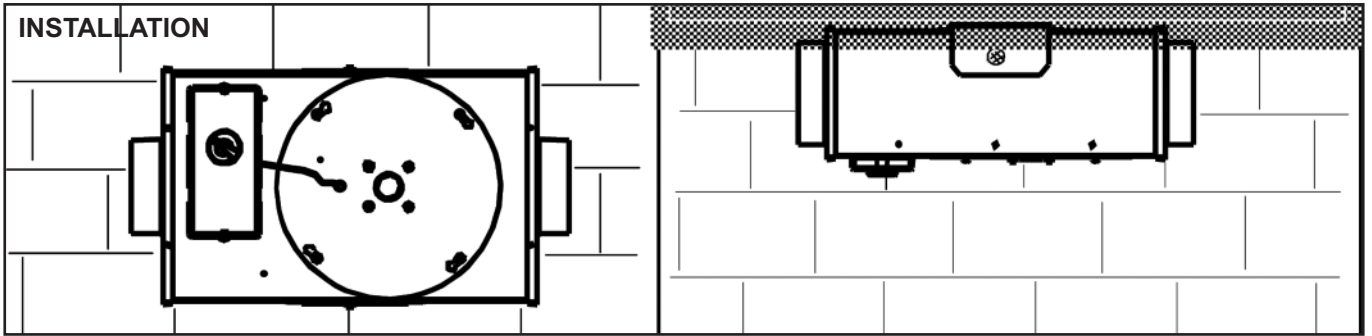

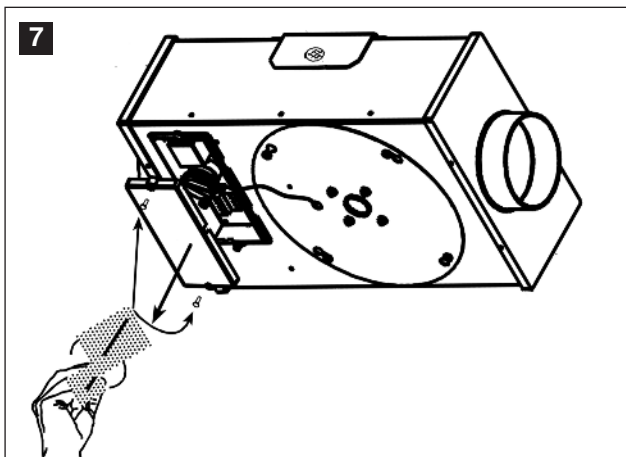
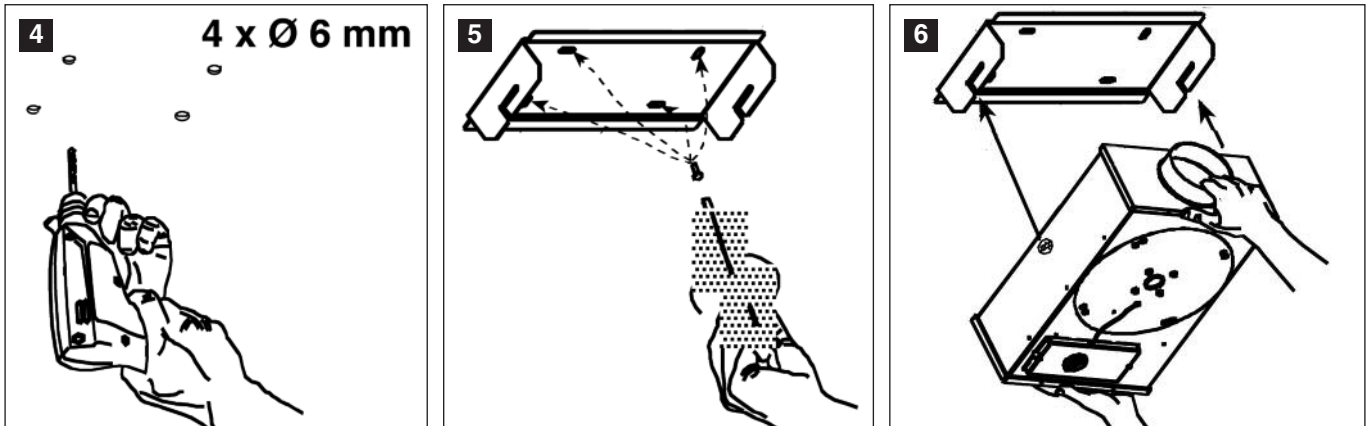

CLEANING AND MAINTENANCE

1. Before carrying out any maintenance or cleaning operations the mains electrical supply **MUST** be disconnected.
2. CLEANING AND MAINTENANCE SHOULD BE CARRIED OUT BY A QUALIFIED PERSON
3. Before attempting to remove the motor impeller assembly disconnect the cable by removing the terminal block inside the control box.
4. Loosen the screws (Fig.8) without taking them off.
5. Rotate slightly and remove the motor-impeller assembly (Fig. 8).
6. Clean the motor-impeller assembly either with a dry brush or a dry cloth.
7. Electrical parts **cannot** be cleaned.
8. Reassemble in the reverse order to above (Fig 9).

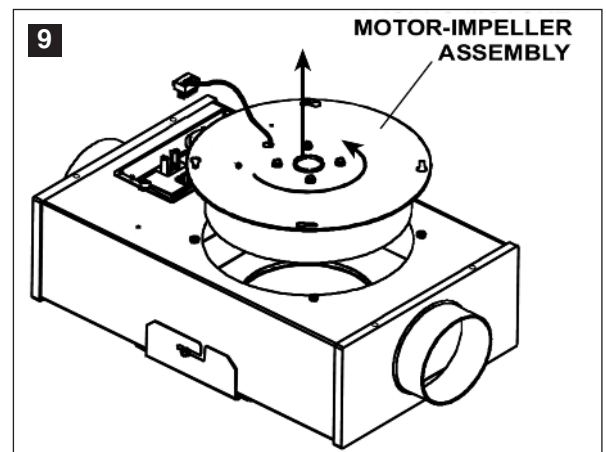
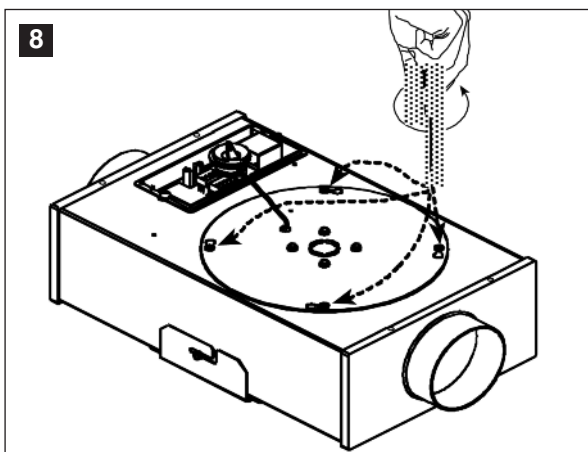

WIRING and COMMISSIONING DIAGRAMS

Standard

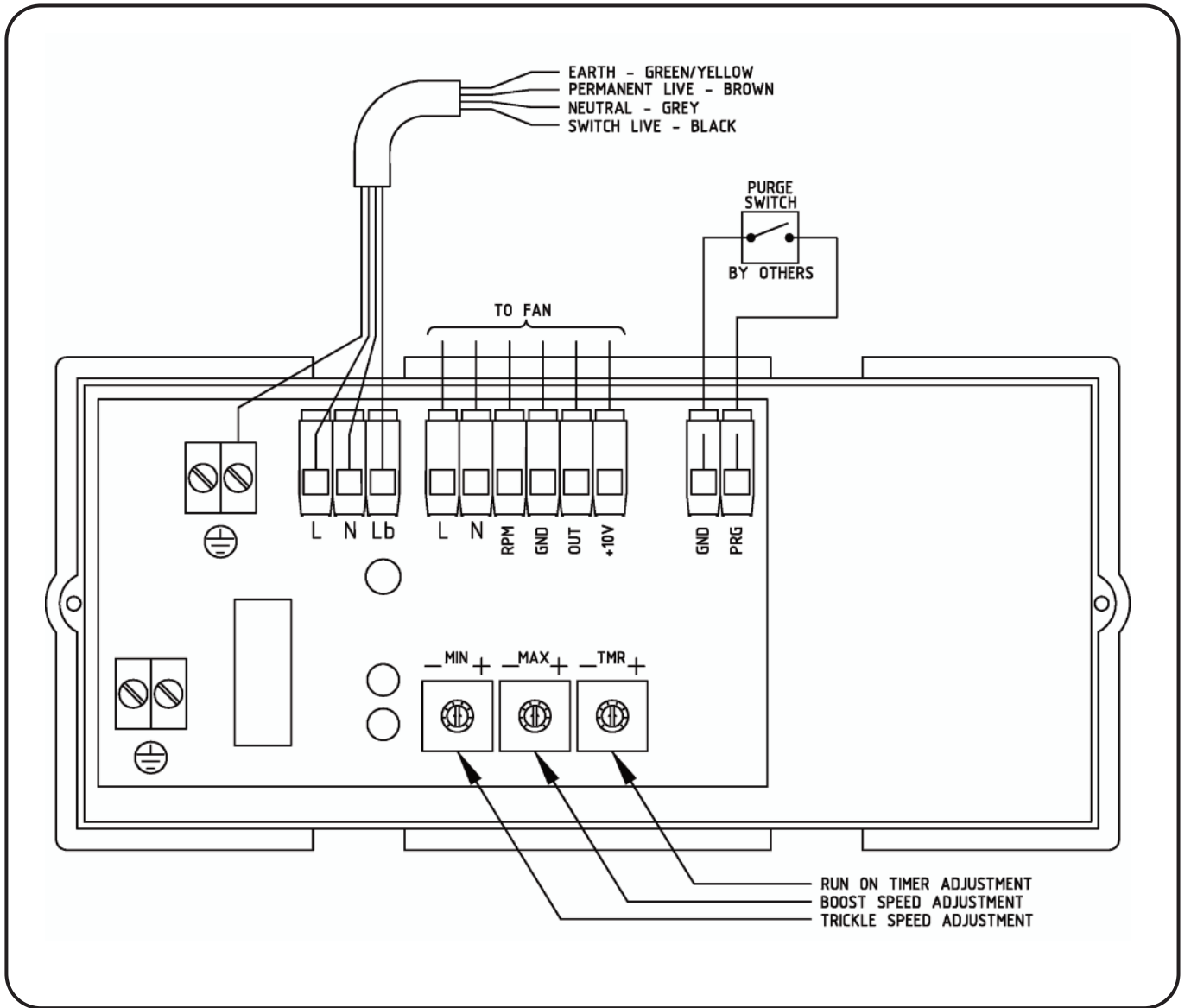

WIRING and COMMISSIONING DIAGRAMS

With Humidistat

